

# InstaGENI Sites and Network: Y1

University of Utah, Princeton University, GPO, Northwestern University, Clemson University, Georgia Tech, University of Kansas, New York University, University of Victoria



# InstaGENI Sites and Network: Y1

University of Utah, Princeton University, GPO, Northwestern University,  
Clemson University, Georgia Tech , University of Kansas , New York University  
University of Victoria

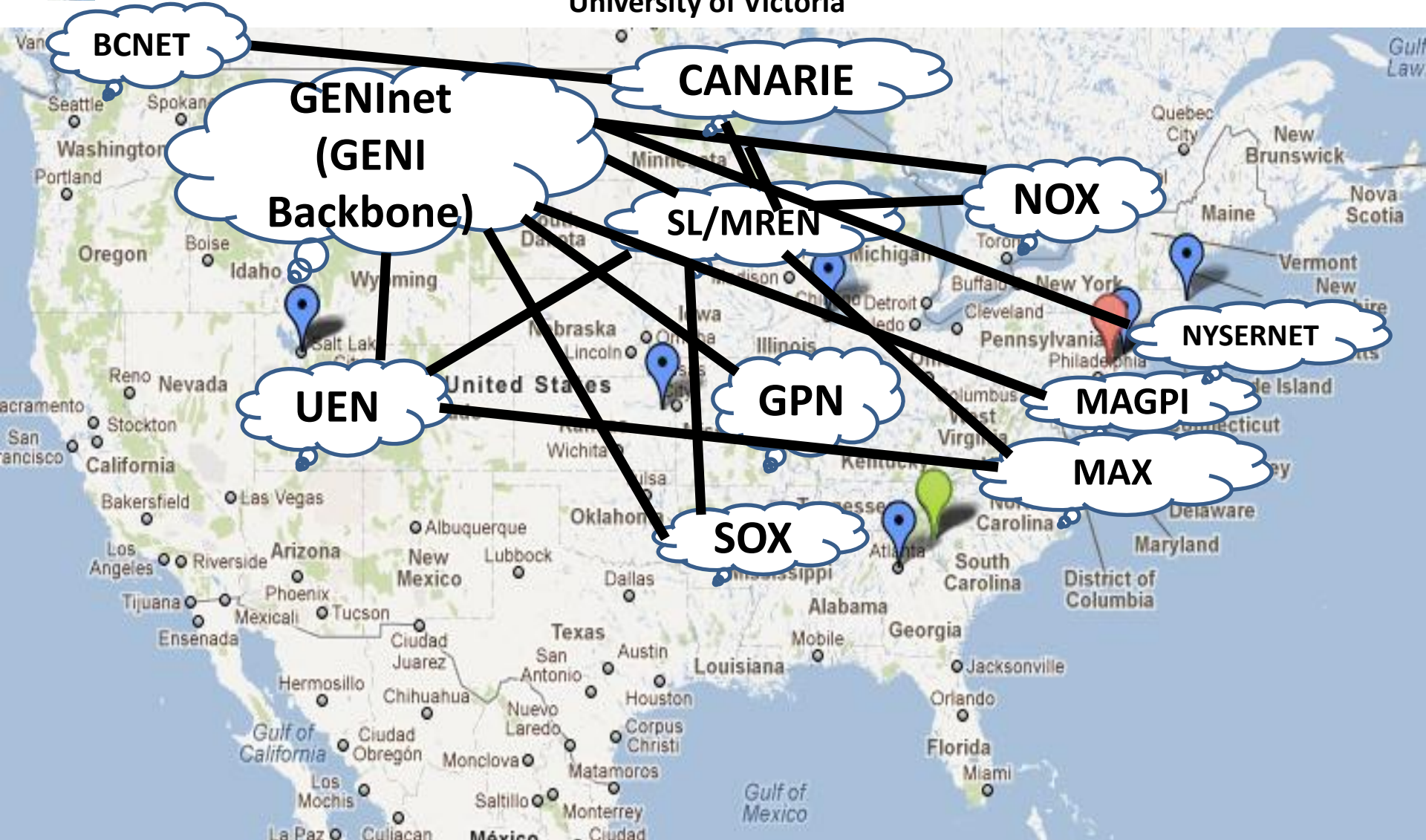



# InstaGENI Sites and Network: Y1

## University of Utah

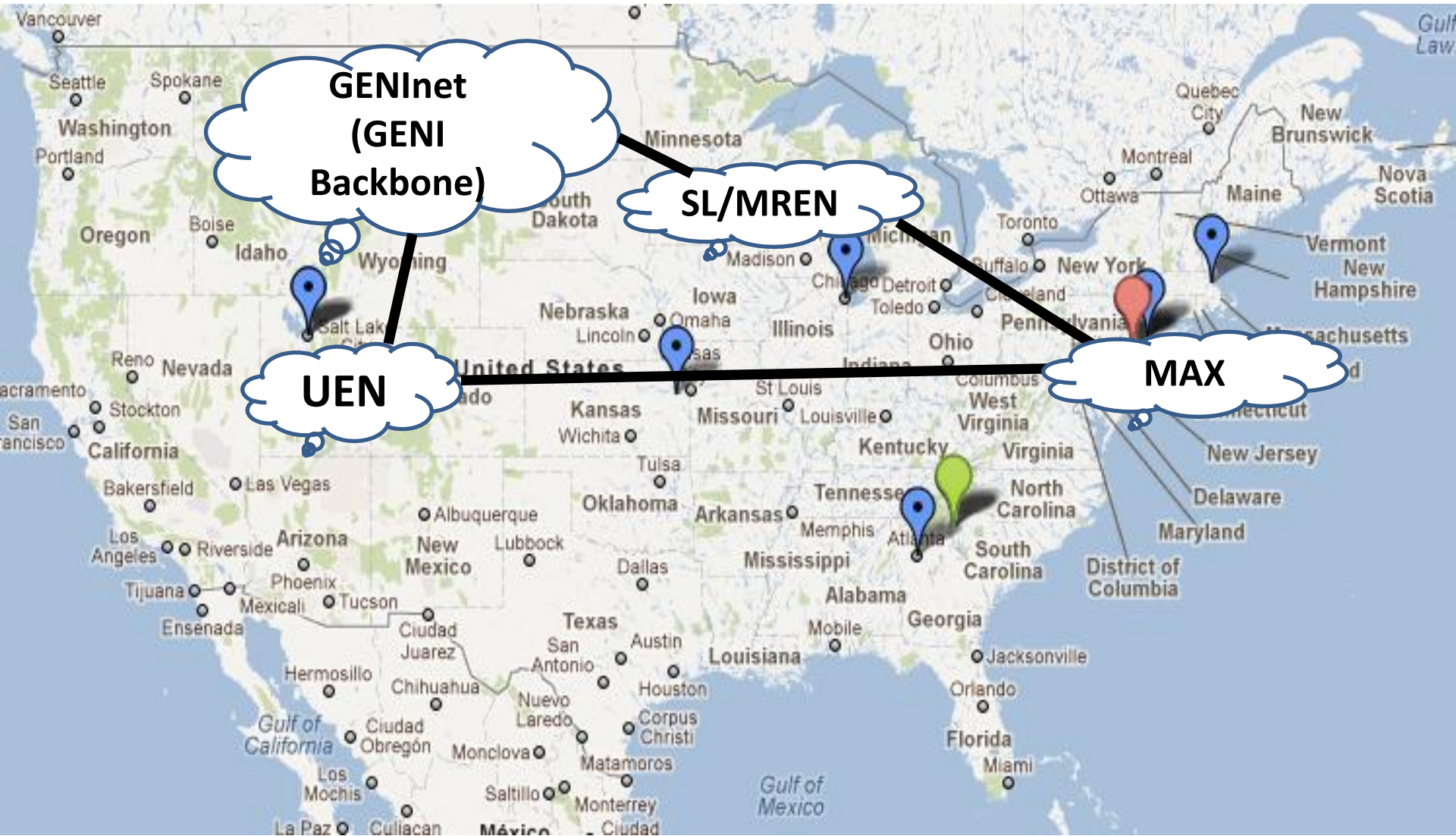

# University of Utah

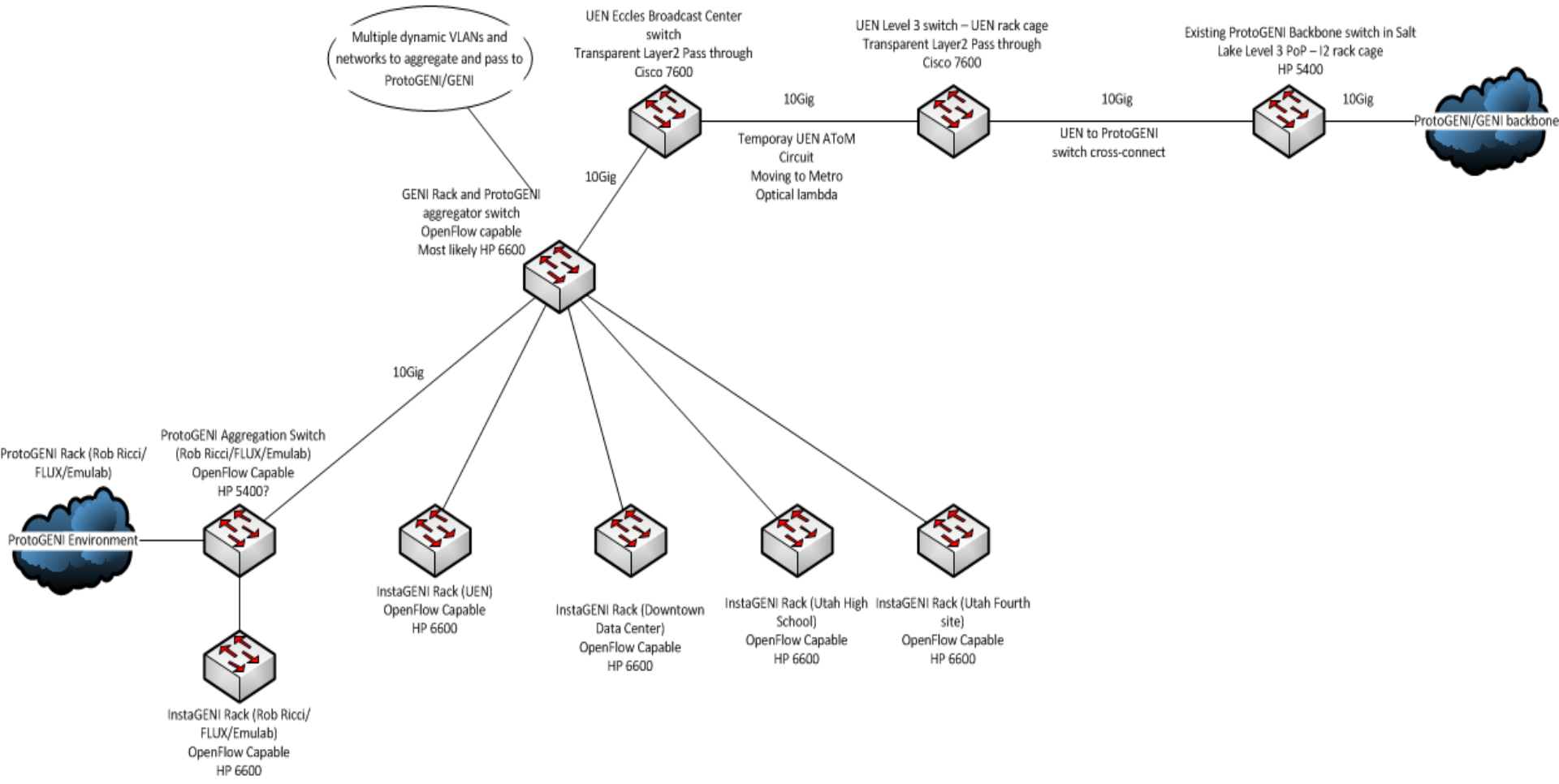



# InstaGENI Sites and Network: Y1

## Princeton University

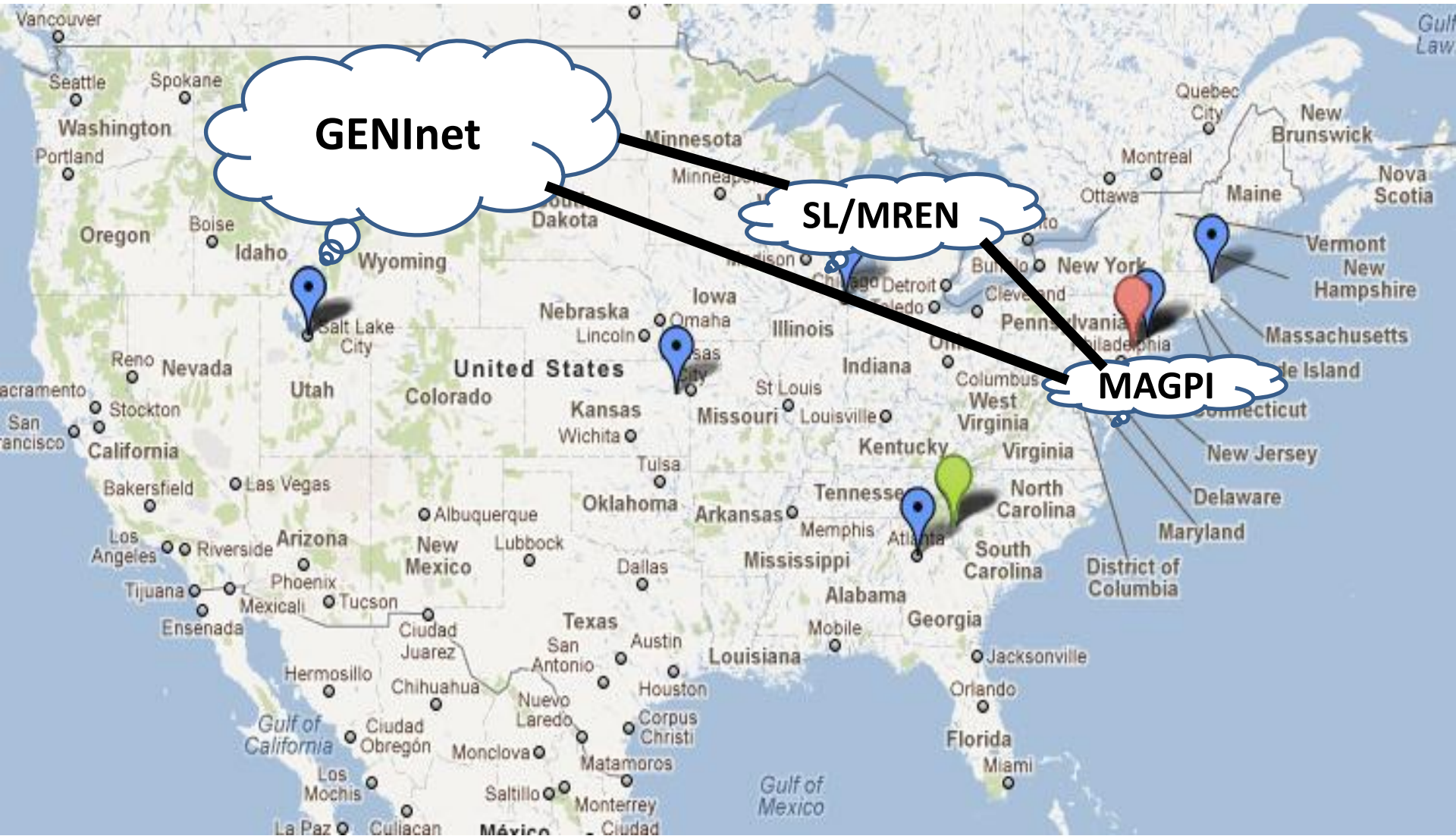

# InstaGENI Sites and Network: Y1

## Princeton University

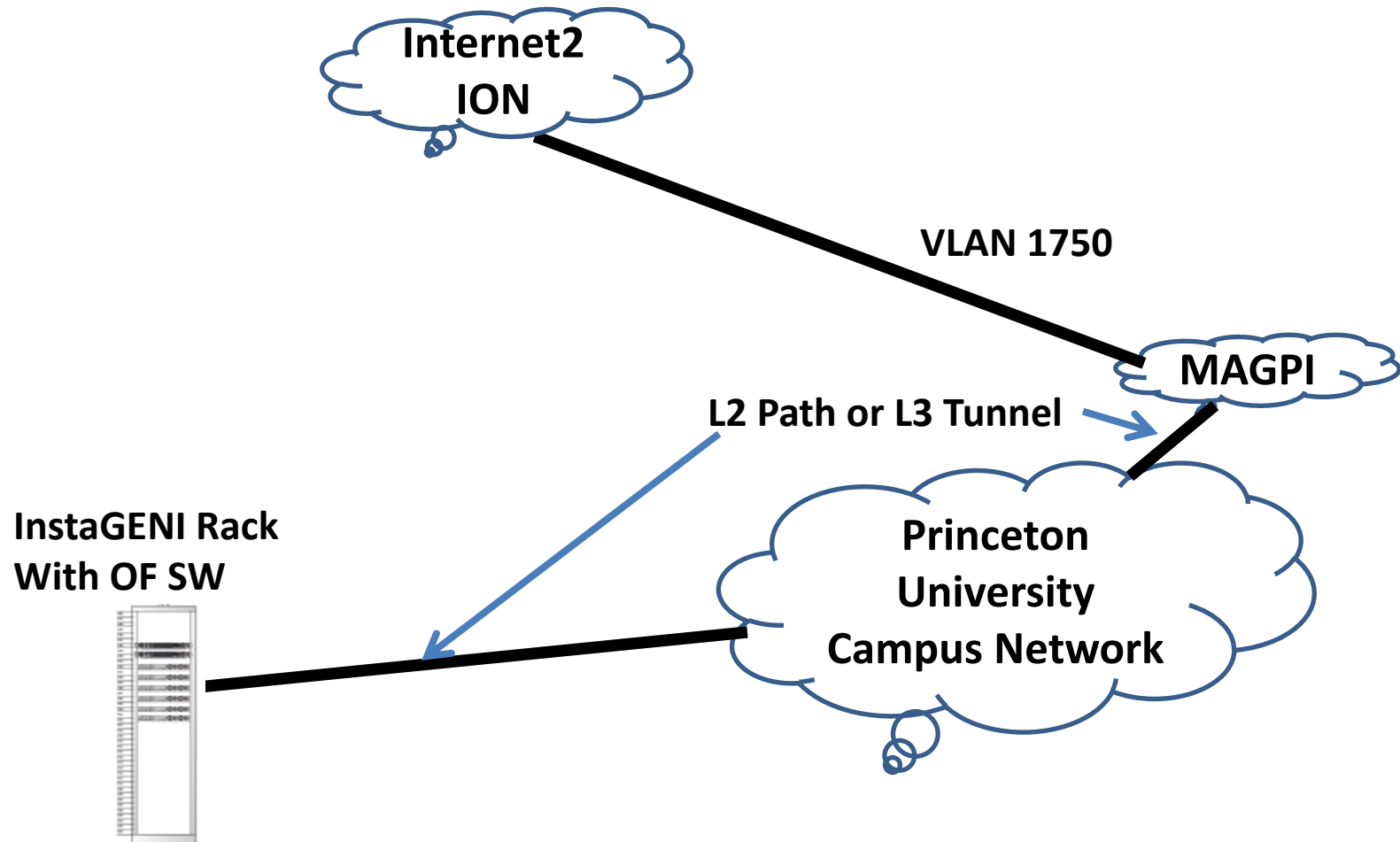

# InstaGENI Sites and Network: Y1 GPO

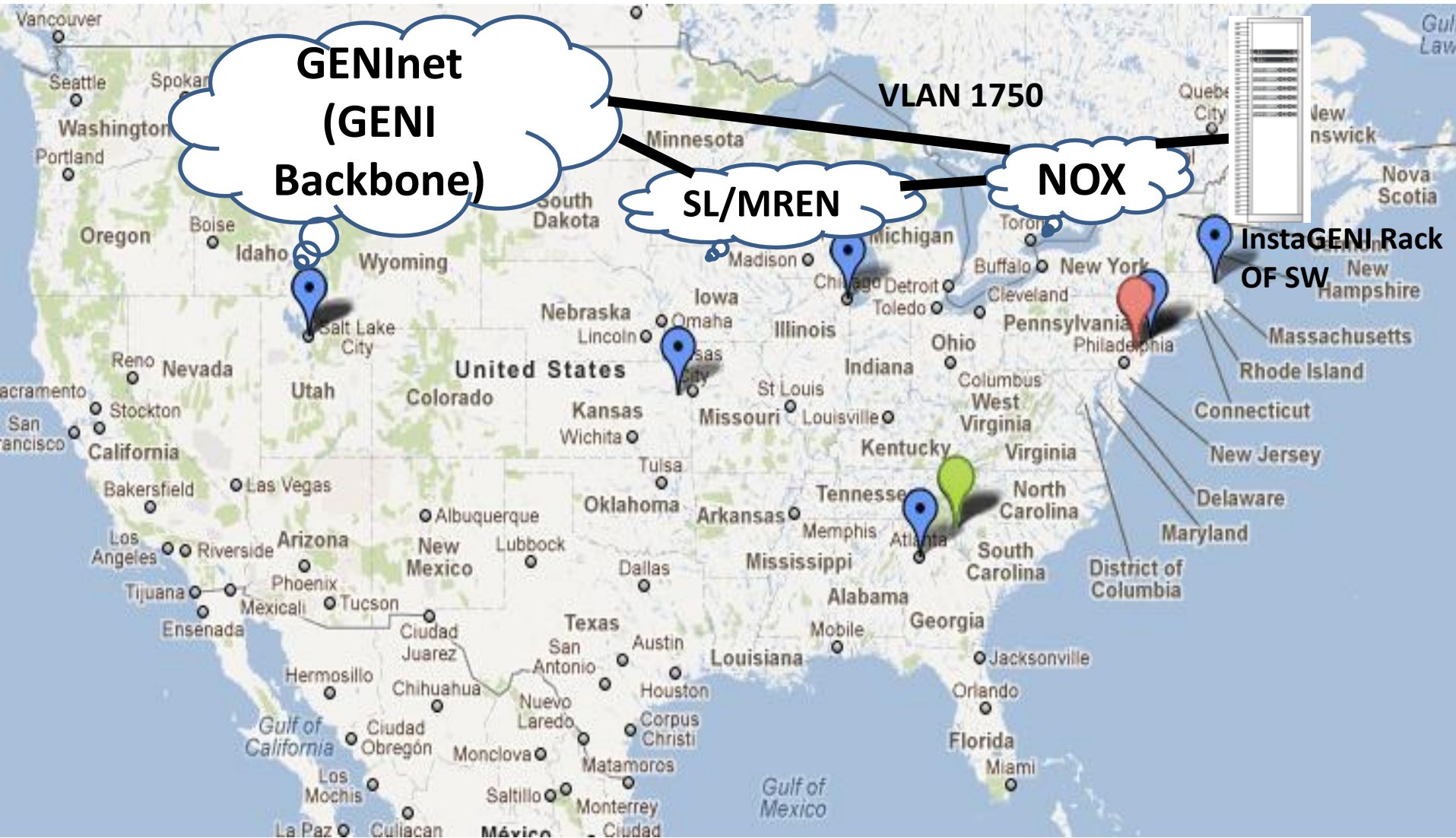



# InstaGENI Sites and Network: Y1

Northwestern University

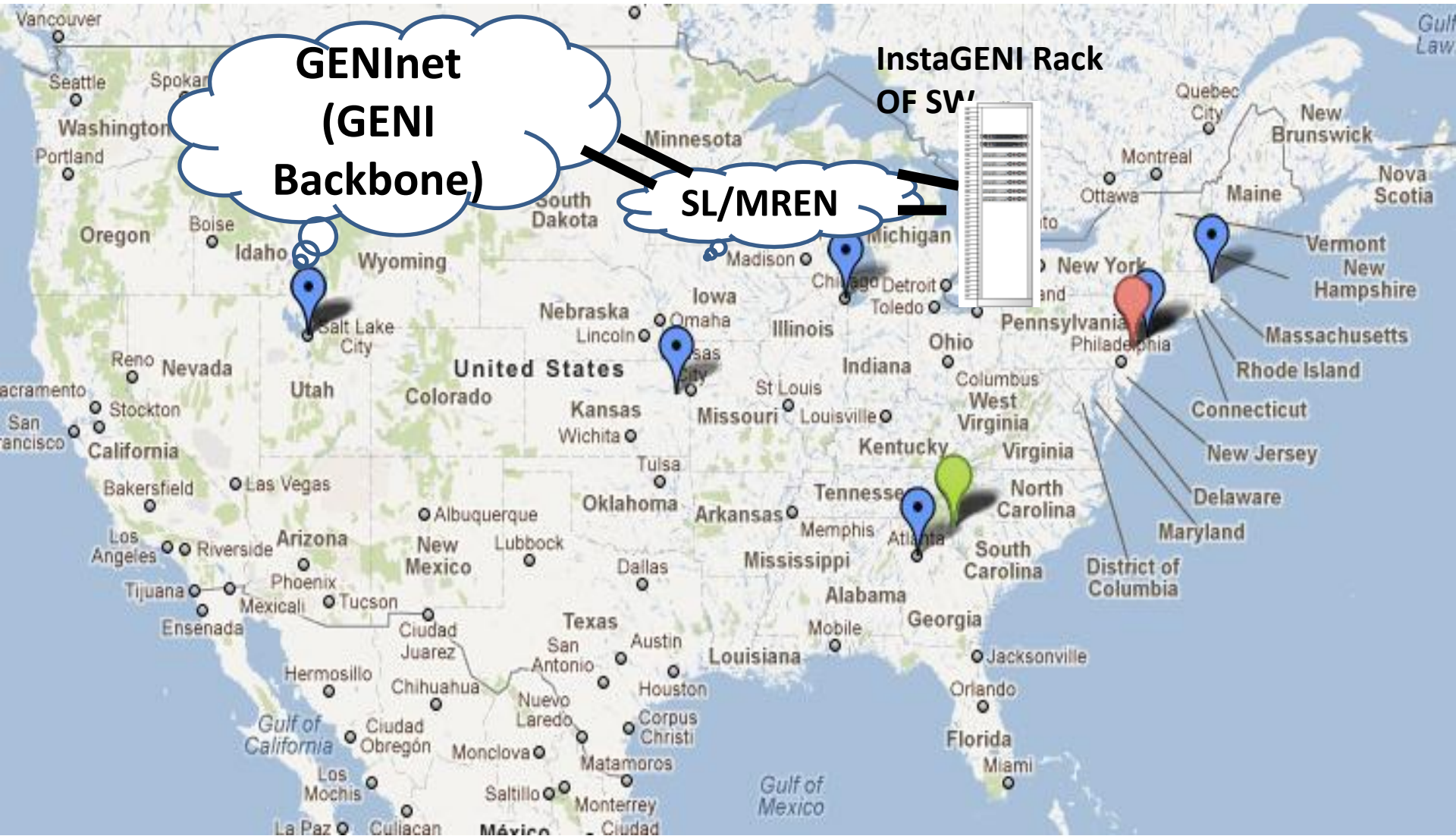



# GENInet at StarLight/MREN Facility

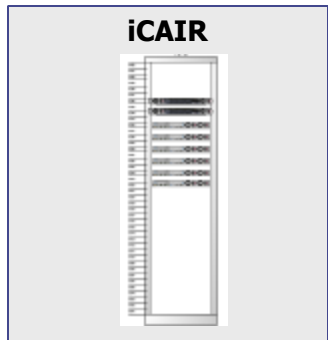
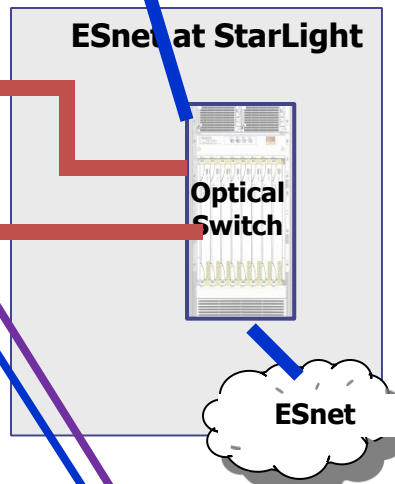
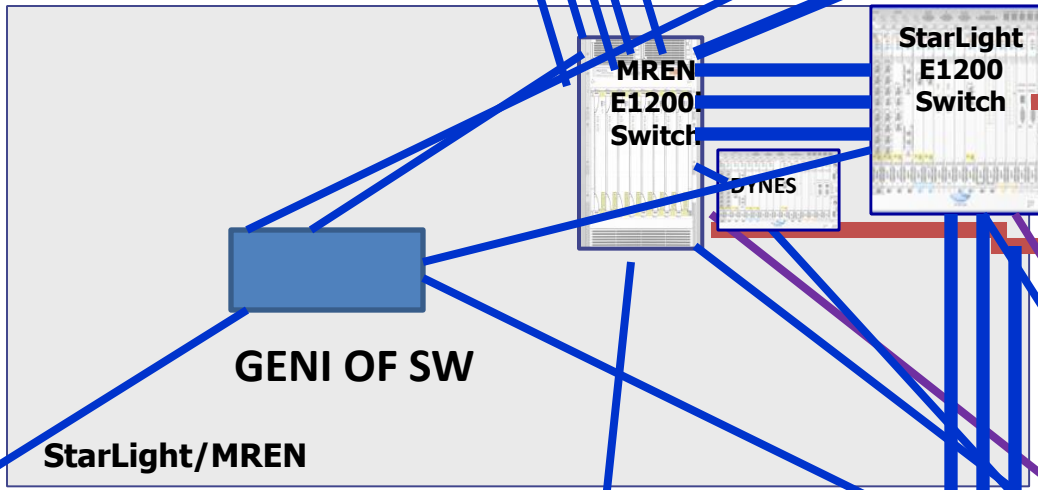
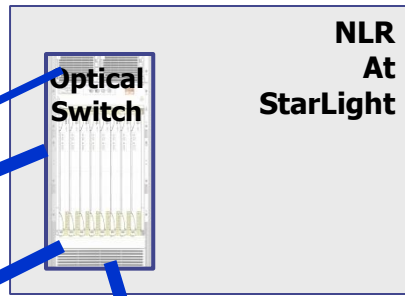

InstaGENI Rack With OF SW iCAIR

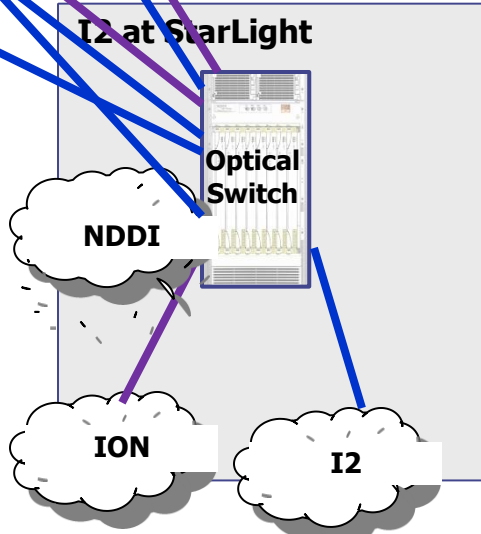

# InstaGENI Sites and Network: Y1

Clemson University, Georgia Tech

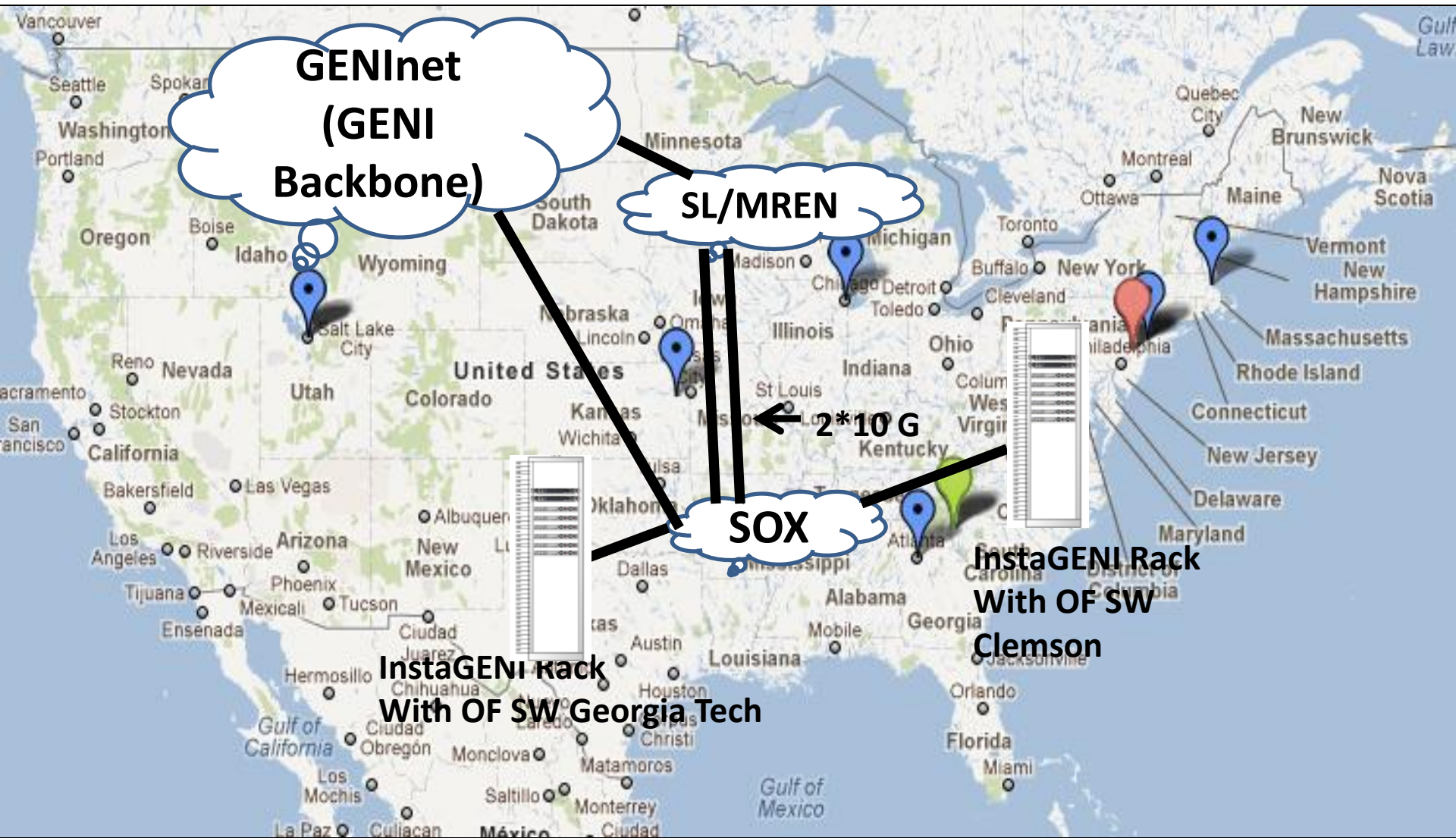



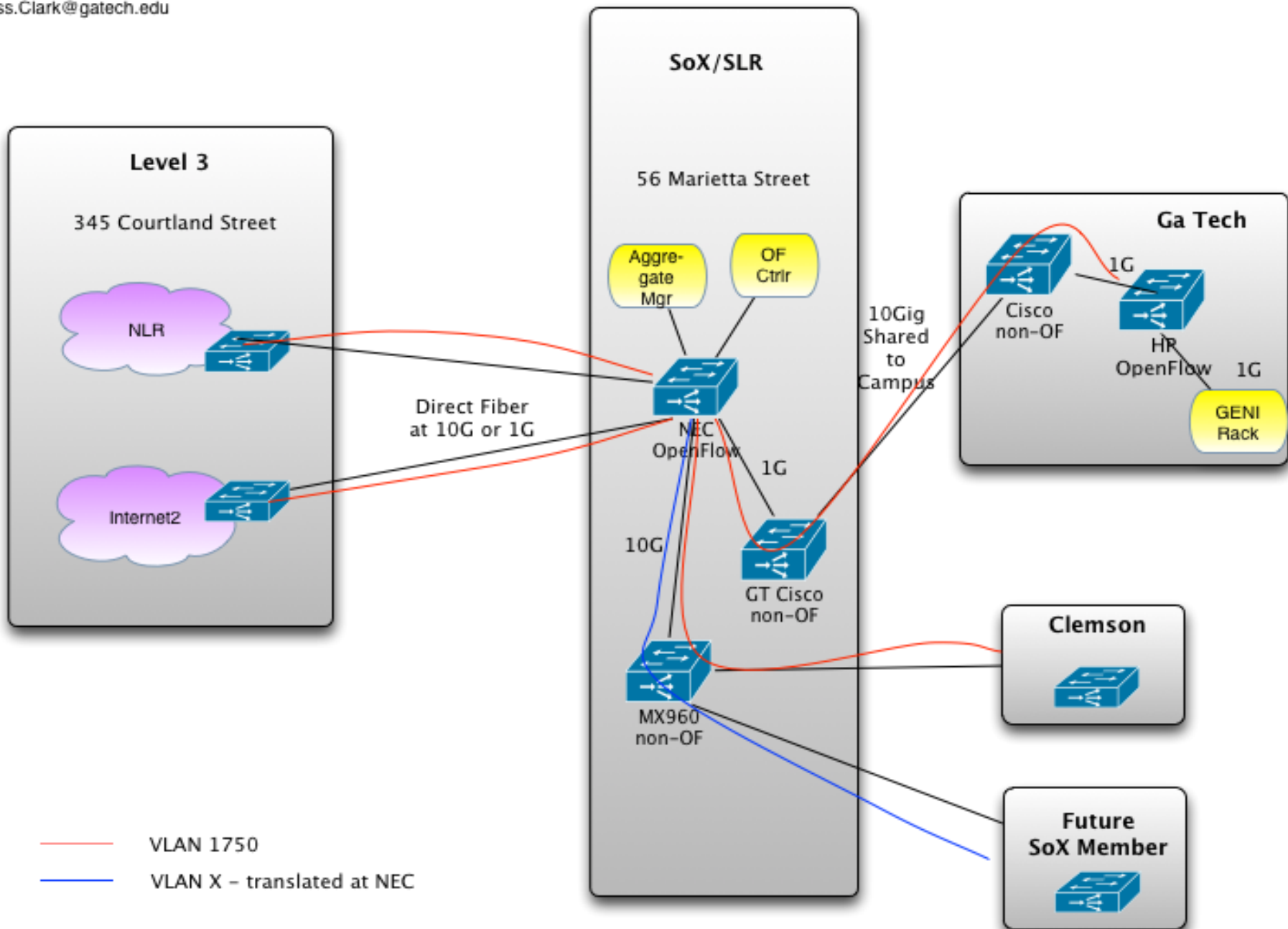

# InstaGENI Sites and Network: Y1

## New York University

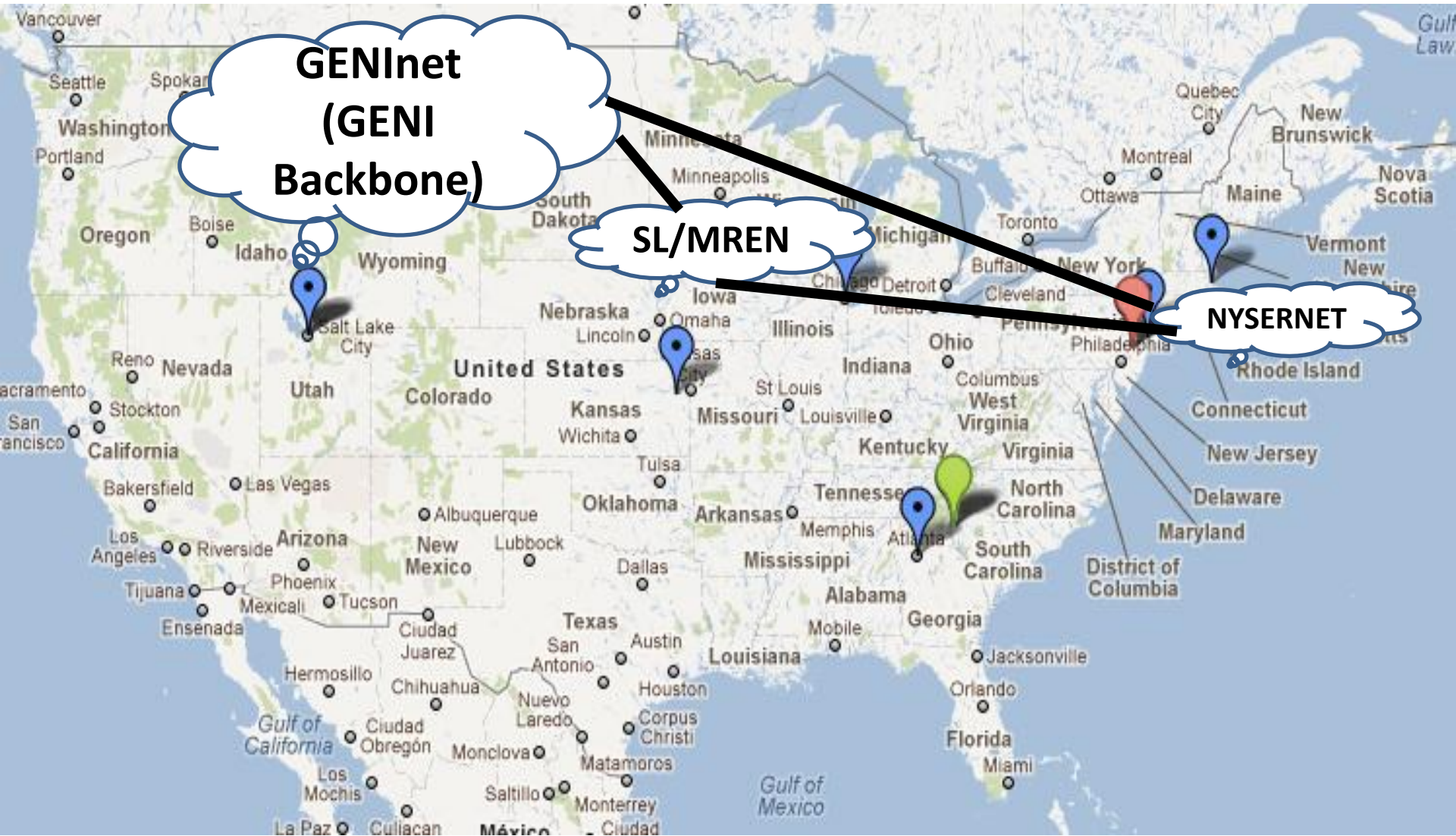



# InstaGENI Sites and Network: Y1

## New York University

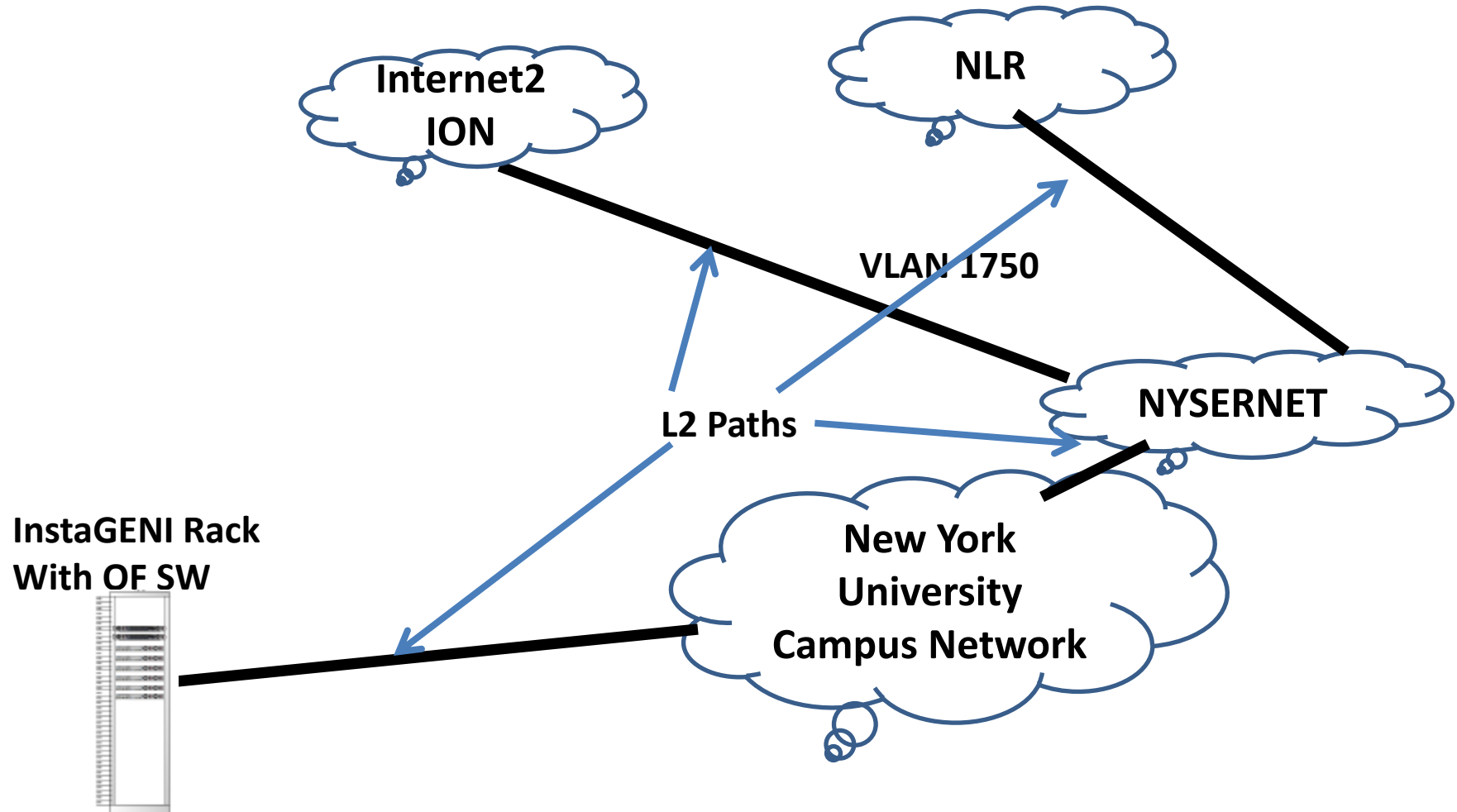

# InstaGENI Sites and Network: Y1

## University of Victoria

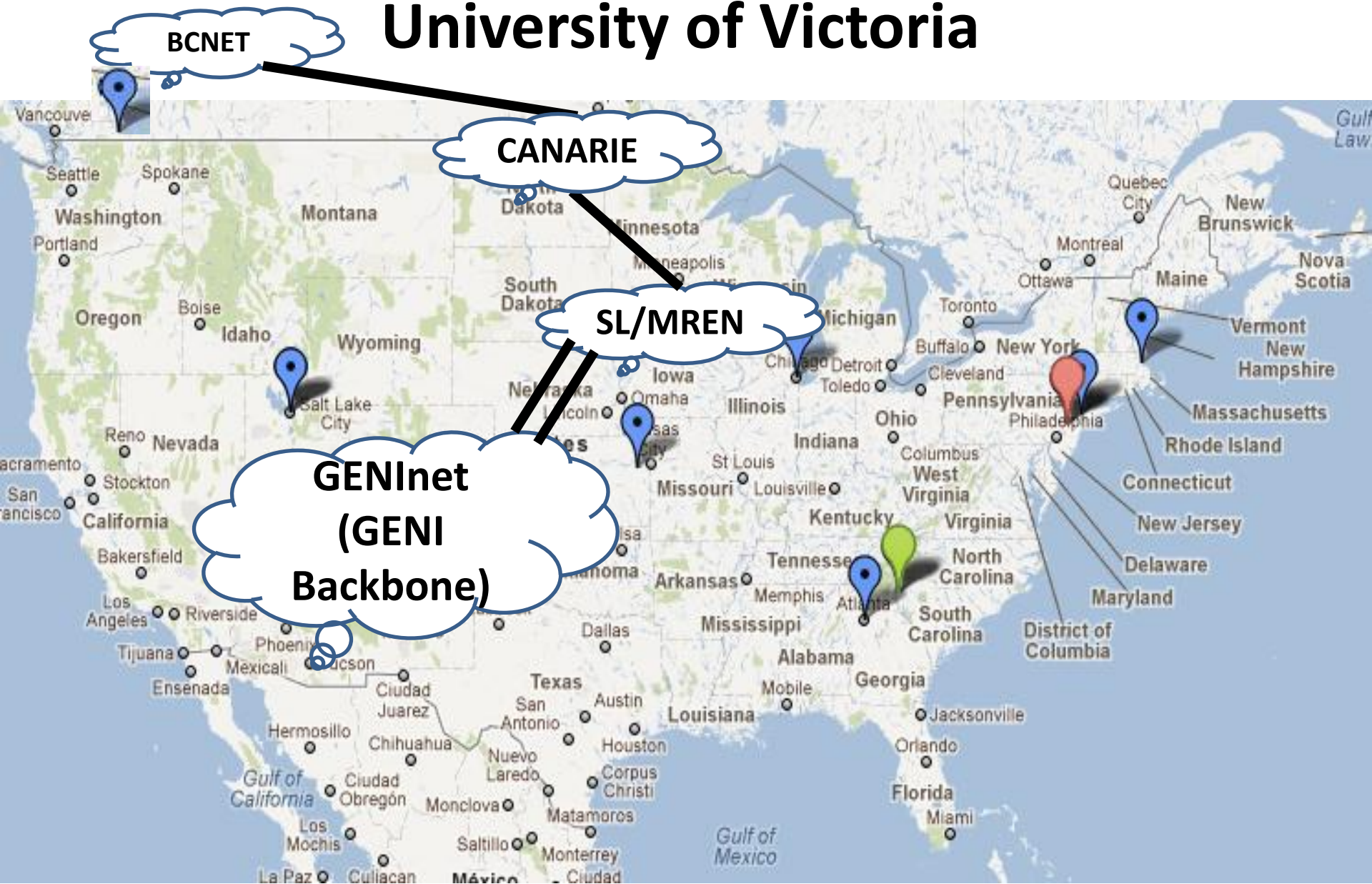



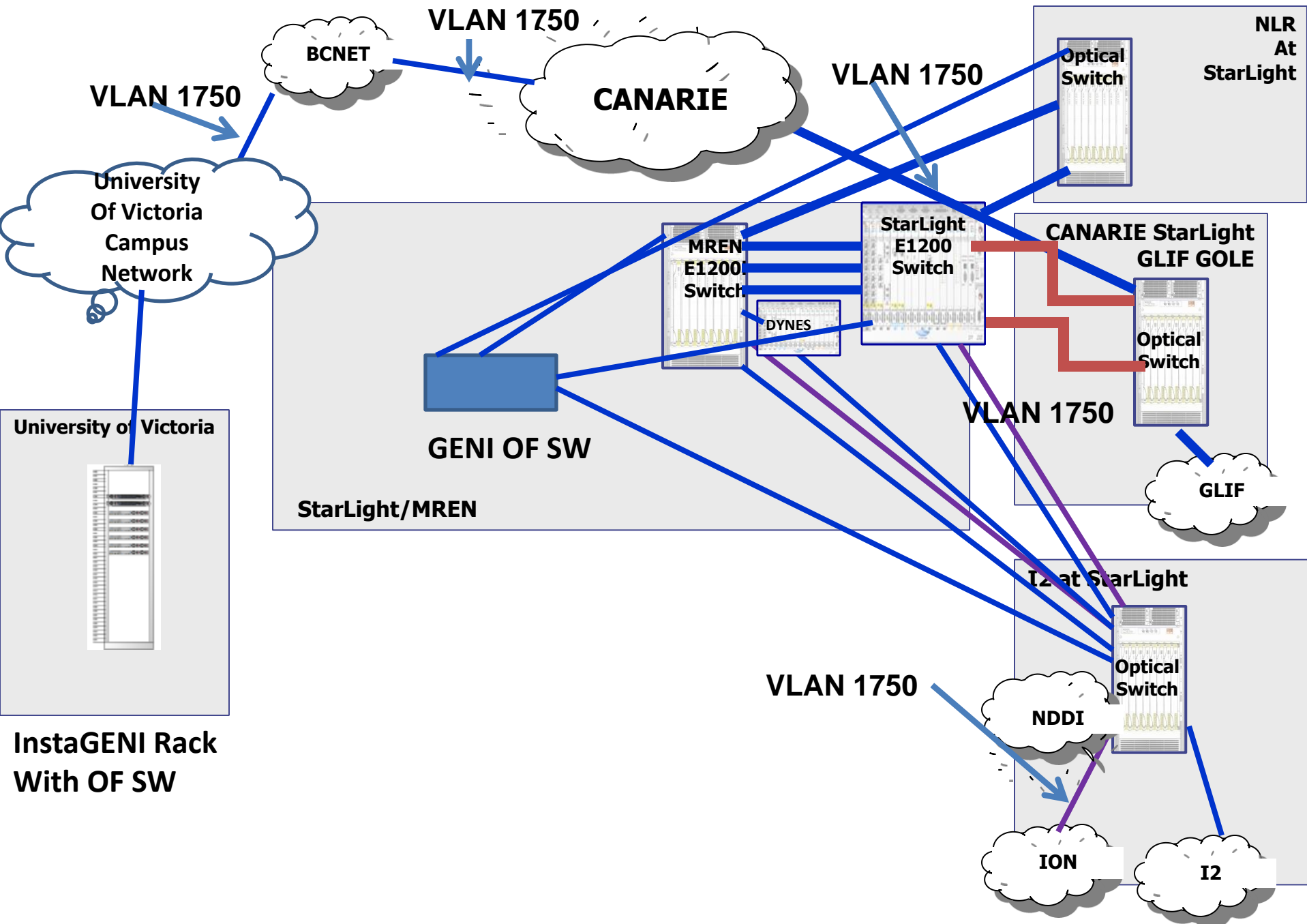

**InstaGENI Rack With OF SW**

